

STAR



ZETA Collection
Optimize Your Work Space

HC

PC

Rich wood grain finishes ranging from light to dark suit any ambience

- Figured Mahogany (FM)
- Henna Cherry (HC)
- Planked Cherry (PC)

FM



Shown in Figured Mahogany

ZA 11-6030



ZA 11-6630



ZA 11-7236



Standard Desk Shells

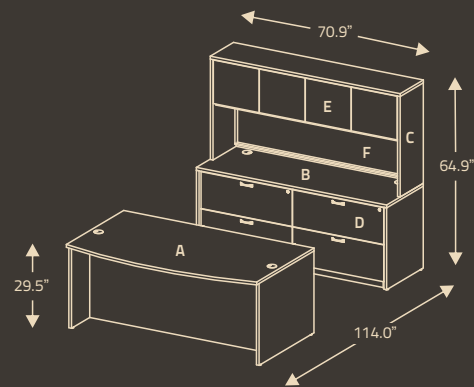

An Executive Office Suite starts with:

- A. Bow Front Desk Shell ZA 15-7242
- B. Credenza Shell ZA 24-7224
- C. Open Storage Hutch ZA 36-7215

Optional as illustrated:

- D. Two Drawer Lateral File x 2 ZA 61-3622
- E. 4 Door Kit for Open Storage Hutch ZA 38-1730
- F. Tack Board / Pencil Tray for Open Storage Hutch ZA 39-6614

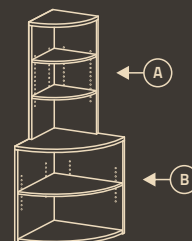

Finish the Suite with a pair of Bookshelf Organizers:

- A. Upper End Cap Bookcase x 2 ZA 72-1515
- B. Lower End Cap Bookcase x 2 ZA 71-2424

Thermally Fused Melamine finish will not peel, fade or stain



Begin your work space design by selecting the right desk size and shape from the wide selection offered.

ZA 15-7242



Bow Front Desk Shell

ZA 19-7236



Peninsula Desk Shell

ZA 14-3636



Corner Desk Shell

Reversible Return/Bridge Shells



Return format or Bridge format
ZA 43-3624



Return format or Bridge format
ZA 43-4824



Credenza Shell
ZA 24-7224



Shown in Planked Cherry



Expand your work area with a reversible return, bridge or credenza shell. A virtually endless number of configurations are possible, limited only by your imagination and the amount of space available.



Cable grommets are placed where needed to conceal and organize equipment wiring

Premium quality metal-to-metal knock down hardware ensures long-lasting structural integrity

Easily adjusted nylon levelers glide on carpet or hard flooring

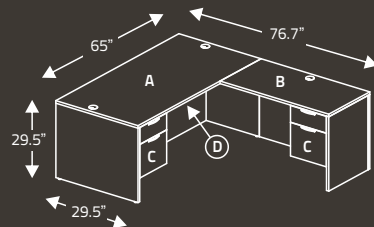

A Mid-Size Reversible L-Desk includes:

- A. Desk Shell ZA 11-6630
- B. Reversible Bridge/Return Shell ZA 43-4824
- Optional as illustrated:**
- C. Box-File Storage Pedestal x 2 ZA 51-1623
- D. Keyboard/Mouse Shelf ZA 01-2812

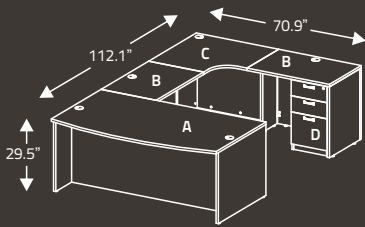

A Reversible U-Group Corner Workstation starts with:

- A. Bow Front Desk Shell ZA 15-7242
 - B. Reversible Bridge/Return Shell x 2 ZA 43-3624
 - C. Corner Desk Shell ZA 14-3636
- Optional as illustrated:**
- D. Box-Box-File Storage Pedestal ZA 53-1623



A Reversible Peninsula L-Desk includes:

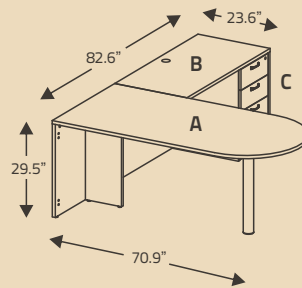

A. Peninsula Desk Shell
ZA 19-7236

B. Reversible
Bridge/Return Shell
ZA 43-4824

Optional as illustrated:
C. Box-Box-File Storage
Pedestal
ZA 53-1623

Shown in Henna Cherry



Shown in Figured Mahogany

Common Desk Configurations

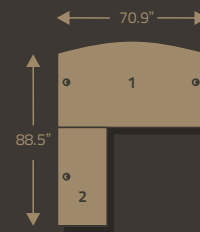

Reversible Bow Front Large L-Desk

- 1. Bow Front Desk Shell ZA 15-7242
- 2. Reversible Bridge/Return Shell ZA 43-4824

Reversible Large U-Group Workstation

- 1. Desk Shell ZA 11-7236
- 2. Reversible Bridge/Return Shell ZA 43-4824
- 3. Credenza Shell ZA 24-7224

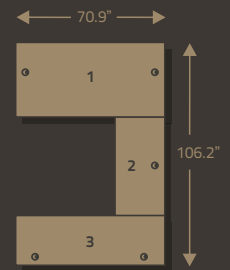

Reversible Compact U-Group Workstation

- 1. Desk Shell ZA 11-6030
- 2. Reversible Bridge/Return Shell ZA 43-3624

Reversible Compact L-Desk

- 1. Desk Shell ZA 11-6030
- 2. Reversible Bridge/Return Shell ZA 43-3624

Reversible Compact Corner L-Desk

- 1. Corner Desk Shell ZA 14-3636
- 2. Reversible Bridge/Return Shell x 2 ZA 43-3624

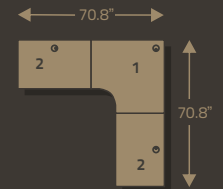

Reversible Peninsula U-Group Corner Workstation

- 1. Peninsula Desk Shell ZA 19-7236
- 2. Reversible Bridge/Return Shell x 2 ZA 43-3624
- 3. Corner Desk Shell ZA 14-3636

Reversible Large L-Credenza

- 1. Credenza Shell ZA 24-7224
- 2. Reversible Bridge/Return Shell ZA 43-4824

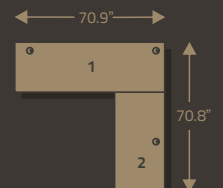

Hutches



Organizer Hutch
ZA 32-7212



Open Storage Hutch
ZA 36-7215

Convertible Cabinets

Top removes for installation under work surface



Storage Cabinet
ZA 79-3622



Two-Drawer Lateral File
ZA 61-3622



Shown in Planked Cherry

Complete your work area with
or adjacent the work surface
storage pedestals or convertible

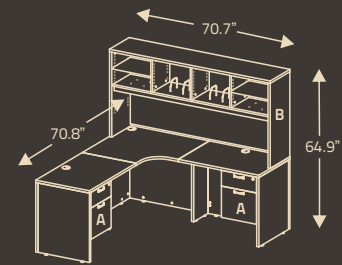

Adding storage components to keep everything
close at hand:

A. Box-File Pedestal x 2

ZA 51-1623

B. Open Storage Hutch

ZA 36-7215



Central locking with fold-over key and
removable core for key-alike suites



Bookshelf dividers keep catalogues
and binders organized



Premium satin brushed metal
drawer handles



Tack board with integrated
tray keeps notes handy and
desktop clutter



Shown in Figured Mahogany

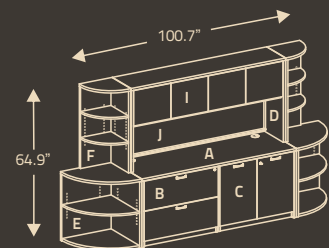

Optimize storage in an executive suite setting using:

A. Credenza Shell

ZA 24-7224

B. Two Drawer Lateral File

ZA 61-3622

C. Storage Cabinet

ZA 79-3622

D. Open Storage Hutch

ZA 36-7215

E. Lower End Cap Bookcase x 2

ZA 71-2424

F. Upper End Cap Bookcase x 2

ZA 72-1515

Optional as illustrated:

I. 4 Door Kit for Open Storage Hutch

ZA 38-1730

J. Tack Board / Pencil Tray
for Open Storage Hutch

ZA 39-6614

Storage Pedestals



Box-File Pedestal
ZA 51-1623



Box-Box-File Pedestal
ZA 53-1623



File-File Pedestal
ZA 54-1623



Multi-Mode
Box-Box-File Pedestal
ZA 56-1623



Multi-Mode
File-File Pedestal
ZA 58-1623

Storage either above, below
desks. Options include hutches,
drawers, and cabinets.

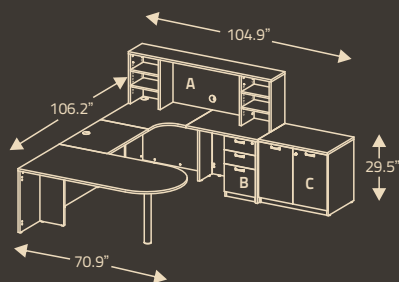

Organize a conferencing workstation with:
 A. Organizer Hutch ZA 32-7212
 B. Box-Box-File Pedestal ZA 53-1623
 C. Storage Cabinet ZA 79-3622



Shown in Henna Cherry



Integrated pencil
tray handy and relieves



Smooth ball-bearing slides with
full-extension on file drawers



All file drawers fit standard letter
and legal size



Adjustable shelves optimize hutch
storage space

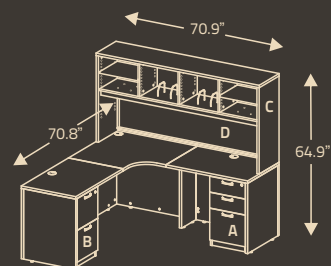

**Maximum storage in a compact home
office work center:**
 A. Box-Box-File Pedestal ZA 53-1623
 B. File-File Pedestal ZA 54-1623
 C. Open Storage Hutch ZA 36-7215
 D. Tack Board / Pencil Tray
for Open Storage Hutch ZA 39-6614



Shown in Figured Mahogany



Shown in Henna Cherry

Once the usual work spaces are furnished, use Zeta and its complementary products to complete the rest of the office. Whether it's the boardroom, reception area, training room, lunch room or the CEO's office there's a perfect matching solution.

1	2
3	4
5	6



Shown in Henna Cherry

1 Bookcase-Storage System

Matching Zeta bookcase system is available in 5 sizes, with optional doors to enclose and lock storage areas

2 Alpha Collection

The coordinating Alpha series features an extra touch of class and style with radius solid wood corners. Zeta storage components and accessories combine with Alpha products to complete a wide range of executive work space configurations.

3 Reception Workstation

A Zeta reception gallery gives a professional first impression to visitors

4 Tucana Training Tables

Tucana series training tables come in a wide range of shapes and sizes, coordinating perfectly with Zeta office systems to furnish any training, lab or conference room.

5 Boardroom

A variety of boardroom table sizes and styles coordinate perfectly with matching Zeta furnishings

6 Capella Desktop Partition Panels

Capella desktop partitions are a perfect complement for the Zeta office system, providing an extra measure of versatility and functionality. More than 40 different components provide privacy in work group settings and expanded work surfaces with transaction tops.



Shown in Figured Mahogany



Shown in Planked Cherry

The final touch for creating a perfect work space is often just the right accessory to enhance functionality or style.

Keyboard / Mouse Shelf
ZA 01-2812

Extra wide to provide enough space for any computing desktop system

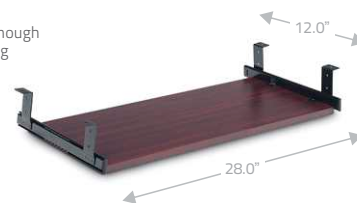

Centre Drawer
ZA 03-2814

The perfect way to organize pens, pencils and avoid desktop clutter



Mobile CPU Trolley
ZA 82-1220

Keeps tower style computers off the floor and accessible when needed



Tack Board / Pencil Tray for Open Storage Hutch
ZA 39-6614

A stylish add-on to the open storage hutch that is great for organizing and relieving clutter

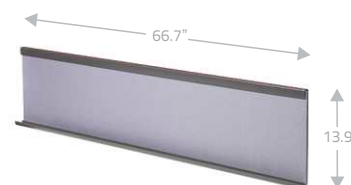

Shown in Figured Mahogany

Removable Lock Core
ZA 50-1111

Easily change lock cores so that one key opens all storage units in a suite



4 Door Kit for Open Storage Hutch
ZA 38-1730

Use to enclose the storage area of the open storage hutch



Shown in Figured Mahogany

ZETA Collection SPECIFICATIONS

DESKS

ZA 11-6030

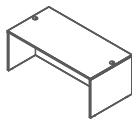

Furniture Dimensions
Width: 59.1" / 150.0 cm
Depth: 29.5" / 75.0 cm
Height: 29.5" / 75.0 cm
Shipping Specifications
Format: RTA
Weight: 114 lbs / 51.8 kg
Volume: 3.8 cu. ft. / 0.107 cbm

ZA 11-6630

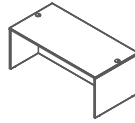

Furniture Dimensions
Width: 65.0" / 165.0 cm
Depth: 29.5" / 75.0 cm
Height: 29.5" / 75.0 cm
Shipping Specifications
Format: RTA
Weight: 126 lbs / 57.3 kg
Volume: 4.1 cu. ft. / 0.1117 cbm

ZA 11-7236

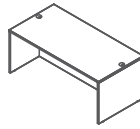

Furniture Dimensions
Width: 70.9" / 180.0 cm
Depth: 35.4" / 90.0 cm
Height: 29.5" / 75.0 cm
Shipping Specifications
Format: RTA
Weight: 153 lbs / 69.5 kg
Volume: 5.3 cu. ft. / 0.150 cbm

ZA 15-7242



Furniture Dimensions
Width: 70.9" / 180.0 cm
Depth: 41.3" / 105.0 cm
Height: 29.5" / 75.0 cm
Shipping Specifications
Format: RTA
Weight: 160 lbs / 72.7 kg
Volume: 6.1 cu. ft. / 0.174 cbm

ZA 19-7236

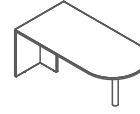

Furniture Dimensions
Width: 70.9" / 180.0 cm
Depth: 35.4" / 90.0 cm
Height: 29.5" / 75.0 cm
Shipping Specifications
Format: RTA
Weight: 108 lbs / 49.1 kg
Volume: 6.0 cu. ft. / 0.171 cbm

ZA 14-3636



Furniture Dimensions
Width: 35.4" / 90.0 cm
Depth: 35.4" / 90.0 cm
Height: 29.5" / 75.0 cm
Shipping Specifications
Format: RTA
Weight: 95 lbs / 43.2 kg
Volume: 3.8 cu. ft. / 0.107 cbm

BRIDGES, RETURNS, CREDENZA

ZA 43-3624

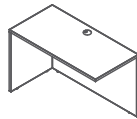

Furniture Dimensions
Width: 35.4" / 90.0 cm
Depth: 23.6" / 60.0 cm
Height: 29.5" / 75.0 cm
Shipping Specifications
Format: RTA
Weight: 66 lbs / 30.0 kg
Volume: 2.3 cu. ft. / 0.066 cbm

ZA 43-4824

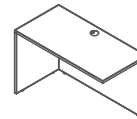

Furniture Dimensions
Width: 47.2" / 120.0 cm
Depth: 23.6" / 60.0 cm
Height: 29.5" / 75.0 cm
Shipping Specifications
Format: RTA
Weight: 84 lbs / 38.2 kg
Volume: 3.1 cu. ft. / 0.087 cbm

ZA 24-7224

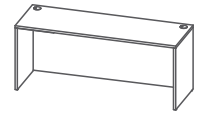

Furniture Dimensions
Width: 70.9" / 180.0 cm
Depth: 23.6" / 60.0 cm
Height: 29.5" / 75.0 cm
Shipping Specifications
Format: RTA
Weight: 115 lbs / 52.3 kg
Volume: 4.3 cu. ft. / 0.121 cbm

HUTCHES, DOOR KIT, TACK BOARD

ZA 32-7212

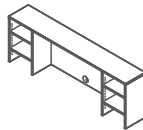

Furniture Dimensions
Width: 70.7" / 179.6 cm
Depth: 11.8" / 30.0 cm
Height: 23.6" / 60.0 cm
Shipping Specifications
Format: RTA
Weight: 95 lbs / 43.0 kg
Volume: 3.6 cu. ft. / 0.101 cbm

ZA 36-7215

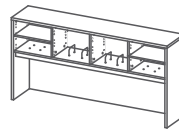

Furniture Dimensions
Width: 70.7" / 179.6 cm
Depth: 15.0" / 38.0 cm
Height: 35.4" / 90.0 cm
Shipping Specifications
Format: RTA
Weight: 135 lbs / 61.4 kg
Volume: 4.7 cu. ft. / 0.134 cbm

ZA 38-1730

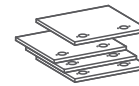

Furniture Dimensions
Width: 17.0" / 43.0 cm
Height: 15.0" / 38.0 cm
Shipping Specifications
Format: RTA
Weight: 22 lbs / 10.0 kg
Volume: 0.7 cu. ft. / 0.019 cbm

ZA 39-6614

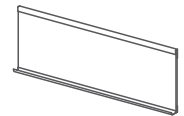

Furniture Dimensions
Width: 66.7" / 169.5 cm
Depth: 2.2" / 5.6 cm
Height: 13.9" / 35.4 cm
Shipping Specifications
Format: RTA
Weight: 8 lbs / 3.6 kg
Volume: 1.0 cu. ft. / 0.028 cbm

PEDESTALS

ZA 51-1623



Furniture Dimensions
Width: 15.6" / 39.6 cm
Depth: 22.8" / 58.0 cm
Height: 19.2" / 48.7 cm
Shipping Specifications
Format: ASSEMBLED
Weight: 53 lbs / 24.1 kg
Volume: 5.2 cu. ft. / 0.147 cbm

ZA 53-1623



Furniture Dimensions
Width: 15.6" / 39.6 cm
Depth: 22.8" / 58.0 cm
Height: 28.4" / 72.2 cm
Shipping Specifications
Format: ASSEMBLED
Weight: 72 lbs / 32.7 kg
Volume: 7.3 cu. ft. / 0.207 cbm

ZA 54-1623



Furniture Dimensions
Width: 15.6" / 39.6 cm
Depth: 22.8" / 58.0 cm
Height: 28.4" / 72.2 cm
Shipping Specifications
Format: ASSEMBLED
Weight: 72 lbs / 32.7 kg
Volume: 7.3 cu. ft. / 0.207 cbm

ZA 56-1623



Furniture Dimensions
Width: 15.7" / 40.0 cm
Depth: 22.8" / 58.0 cm
Height: 29.5" / 75.0 cm
Shipping Specifications
Format: ASSEMBLED
Weight: 92 lbs / 41.8 kg
Volume: 7.7 cu. ft. / 0.217 cbm

ZA 58-1623

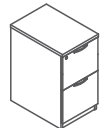

Furniture Dimensions
Width: 15.7" / 40.0 cm
Depth: 22.8" / 58.0 cm
Height: 29.5" / 75.0 cm
Shipping Specifications
Format: ASSEMBLED
Weight: 92 lbs / 41.8 kg
Volume: 7.7 cu. ft. / 0.217 cbm

LATERAL FILE, STORAGE, CORNER ORGANIZERS

ZA 61-3622

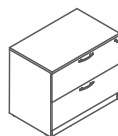

Furniture Dimensions
Width: 34.1" / 86.7 cm
Depth: 22.8" / 58.0 cm
Height: 29.4" / 74.7 cm
Shipping Specifications
Format: ASSEMBLED
Weight: 151 lbs / 68.6 kg
Volume: 15.9 cu. ft. / 0.450 cbm

ZA 79-3622

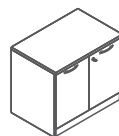

Furniture Dimensions
Width: 34.1" / 86.7 cm
Depth: 22.8" / 58.0 cm
Height: 29.4" / 74.7 cm
Shipping Specifications
Format: RTA
Weight: 111 lbs / 50.5 kg
Volume: 3.8 cu. ft. / 0.107 cbm

ZA 71-2424

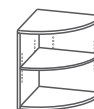





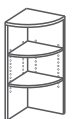



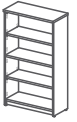
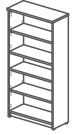
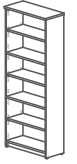

Furniture Dimensions
Width: 23.6" / 60.0 cm
Depth: 23.6" / 60.0 cm
Height: 29.5" / 75.0 cm
Shipping Specifications
Format: RTA
Weight: 68 lbs / 30.9 kg
Volume: 2.6 cu. ft. / 0.073 cbm

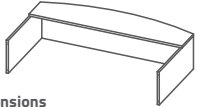
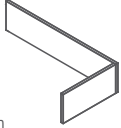
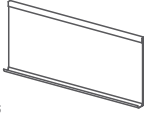
ZA 72-1515

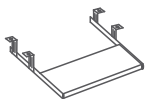
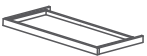

Furniture Dimensions
Width: 15.0" / 38.0 cm
Depth: 15.0" / 38.0 cm
Height: 35.4" / 90.0 cm
Shipping Specifications
Format: RTA
Weight: 37 lbs / 16.8 kg
Volume: 1.6 cu. ft. / 0.044 cbm

BOOKCASES, DOOR KIT	ZA 72-3032	ZA 73-4432	ZA 74-5632	ZA 75-6632	ZA 76-8232	ZA 70-2832
						
	Furniture Dimensions Width: 31.5" / 80.5 cm Depth: 13.8" / 35.0 cm Height: 29.5" / 75.0 cm	Furniture Dimensions Width: 31.5" / 80.5 cm Depth: 13.8" / 35.0 cm Height: 43.8" / 111.3 cm	Furniture Dimensions Width: 31.5" / 80.5 cm Depth: 13.8" / 35.0 cm Height: 55.0" / 139.8 cm	Furniture Dimensions Width: 31.5" / 80.5 cm Depth: 13.8" / 35.0 cm Height: 65.0" / 165.1 cm	Furniture Dimensions Width: 31.5" / 80.5 cm Depth: 13.8" / 35.0 cm Height: 80.5" / 204.5 cm	Furniture Dimensions Width: 31.2" / 79.4 cm Depth: 0.7" / 1.8 cm Height: 25.3" / 64.4 cm
	Shipping Specifications Format: RTA Weight: 65 lbs / 29.5 kg Volume: 2.2 cu. ft. / 0.062cbm	Shipping Specifications Format: RTA Weight: 95 lbs / 43.2 kg Volume: 2.9 cu. ft. / 0.082cbm	Shipping Specifications Format: RTA Weight: 110 lbs / 50.0 kg Volume: 3.9 cu. ft. / 0.110cbm	Shipping Specifications Format: RTA Weight: 125 lbs / 56.8 kg Volume: 4.6 cu. ft. / 0.130cbm	Shipping Specifications Format: RTA Weight: 140 lbs / 63.6 kg Volume: 5.7 cu. ft. / 0.161cbm	Shipping Specifications Format: RTA Weight: 15 lbs / 6.8 kg Volume: 0.5 cu. ft. / 0.014cbm
	RECEPTION GALLERY, RETURN, TACK BOARD, FILE ORGANIZER	ZA 31-7236	ZA 31-4824	ZA 39-4612 CH	ZA 37-6012	
						
Furniture Dimensions Width: 70.8" / 180.0 cm Depth: 41.3" / 105.0 cm Height: 16.7" / 42.5 cm		Furniture Dimensions Width: 47.2" / 120.0 cm Depth: 23.6" / 60.0 cm Height: 15.7" / 40.0 cm	Furniture Dimensions Width: 45.3" / 115.0 cm Depth: 2.2" / 5.6 cm Height: 11.8" / 30.0 cm	Furniture Dimensions Width: 15.9" / 40.4 cm Depth: 9.8" / 25.0 cm Height: 11.1" / 28.2 cm		
Shipping Specifications Format: RTA Weight: 70 lbs / 31.8 kg Volume: 2.5 cu. ft. / 0.070 cbm		Shipping Specifications Format: RTA Weight: 30 lbs / 13.6 kg Volume: 1.2 cu. ft. / 0.034 cbm	Shipping Specifications Format: RTA Weight: 6 lbs / 2.7 kg Volume: 0.5 cu. ft. / 0.014 cbm	Shipping Specifications Format: RTA Weight: 20 lbs / 9.1 kg Volume: 0.5 cu. ft. / 0.014 cbm		
BOARDROOM	ZA 91-4242	ZA 91-4848	ZA 95-9645			
						
	Furniture Dimensions Width: 39.5" / 100.0 cm Depth: 39.5" / 100.0 cm Height: 29.5" / 75.0 cm	Furniture Dimensions Width: 47.2" / 120.0 cm Depth: 47.2" / 120.0 cm Height: 29.5" / 75.0 cm	Furniture Dimensions Width: 94.5" / 240.0 cm Depth: 47.2" / 120.0 cm Height: 29.5" / 75.0 cm			
Shipping Specifications Format: RTA Weight: 65 lbs / 29.5 kg Volume: 3.6 cu. ft. / 0.101 cbm	Shipping Specifications Format: RTA Weight: 84 lbs / 38.2 kg Volume: 5.0 cu. ft. / 0.141 cbm	Shipping Specifications Format: RTA Weight: Box 1 130 lbs / 59.1 kg; Box 2 52lbs / 23.6 kg Volume: Box 1 5.0 cu. ft. / 0.141 cbm; Box 2 2.0 cu. ft. / 0.056cbm				
ACCESSORIES	ZA 01-2812	ZA 03-2814	ZA 82-1220	ZA 50-1111		
	Keyboard / Mouse Shelf	Centre Drawer	Mobile CPU Trolley	Removable Lock Core		
						
	Furniture Dimensions Width: 28.0" / 71.1 cm Depth: 12.0" / 30.5 cm Height: 0.7" / 1.8 cm	Furniture Dimensions Width: 30.9" / 78.6 cm Depth: 22.2" / 56.3 cm Height: 2.1" / 5.3 cm	Furniture Dimensions Width: 10.2" / 26.0 cm Depth: 19.1" / 48.5 cm Height: 15.0" / 38.0 cm	Shipping Specifications Weight: 1 lbs / 0.5 kg		
Shipping Specifications Format: RTA Weight: 11 lbs / 5.0 kg Volume: 0.7 cu. ft. / 0.021 cbm	Shipping Specifications Format: RTA Weight: 12 lbs / 5.5 kg Volume: 0.4 cu. ft. / 0.011 cbm	Shipping Specifications Format: RTA Weight: 9 lbs / 4.1 kg Volume: 0.4 cu. ft. / 0.013 cbm				

The Zeta collection from Star Quality includes an extensive array of office furniture. Each piece blends a perfect balance of time-tested style, exceptional value and durable commercial grade materials. All are offered in a variety of finishes and sizes to suit almost any need. The modular design of this furniture provides ease of assembly for components best suited to RTA (ready-to-assemble) format, together with the convenience of fully assembled file storage units. With Zeta you can furnish your entire work space efficiently, stylishly and economically.

Due to continuous product improvements, Star reserves the right to change specifications, material, design or packaging without prior notice. Some models may be replaced or discontinued at any time without notice. Due to variations in the printing process, the actual colour and texture of products depicted may not be exactly as shown.



Environmental Stewardship

Star Quality is committed to supplying office furniture products in an environmentally responsible manner. We are proud to partner with like-minded corporate citizens who align environmental stewardship with their company's core values and goals. To fully optimize responsible environmental stewardship, due consideration is given at every stage of the product life cycle from initial design concept, through to end-of-life disposal. Star Quality has adopted thorough guidelines to reduce its environmental impact, including:

- Product designs allowing easy adaptation and reconfiguration, enabling change to suit the applicable work environment thereby avoiding product obsolescence.
- Product sizes that provide maximum utilization of raw materials, reducing off-cuts and waste.
- Products that ship flat-packed and ready-to-assemble, maximizing shipping efficiency and minimizing fossil fuel consumption.
- Using composite wood products made with 100% recovered and recycled wood fibers. Only supporting raw material suppliers that adopt a "No new trees harvested" policy, meaning that all wood chips must come from sawmills, planing mills and other sources where the chips are a waste by-product of primary products.
- Utilizing low formaldehyde content composite wood that meets CARB* guidelines.
- Using recycled paper and water-based amino resins in the lamination and treatment processes.
- Packaging sized to fit finished products tightly, reducing unnecessary material.
- Designing products that can be either recycled or reused at the end of the product life.

*California Air Resources Board



Star Quality warrants the Thermally-Fused Laminate (TFL) finish of its product will not peel, fade or stain for the lifetime of the original purchaser of the product. Star Quality will replace any TFL component or part that is found to be defective in material or workmanship by the original purchaser. A three-year warranty applies to any other component or part that is found to be defective in either material or workmanship. Other limitations and exclusions may apply to this warranty policy, contact Star Quality for details.



Star Quality Office Furniture Mfg. Ltd.
75 Westmore Drive, Toronto, ON M9V 3Y6
Tel: 416-741-8000 Fax: 416-741-7900
www.starquality.ca

Printed in Canada

Quality - Value - Style